

Teacup and Coffee Cup Blocks (paper pieced)

This pattern contains 6 pages, and includes:

- four 4" **Teacup and Coffee Cup** block patterns, and their mirror image patterns
- table of percentages for resizing 4" block when photocopying
- coloring page to experiment with your own color ideas

Important: To ensure the pattern size is accurate when printing from Adobe Reader, be sure to UNcheck the "Fit to Page" box (earlier versions of Reader) or the "Choose Paper Source by PDF page size" box (latest versions). After printing the pattern pages, verify the size accuracy using the "Print Size Check" arrow, which measures exactly 1" (2.54 cm) from tip to tip.

For other common finished block sizes, photocopy a 4" block at the percentages shown in the table at right.

Remember to add 1/4" seam allowances around each section while piecing. If you've enlarged or reduced the original pattern, remember to adjust your marked seam allowance to a true 1/4".



To get a finished block this size:	copy 4" block at this percentage:
3"	75%
5"	125%
6"	150%
7"	175%
8"	200%
9"	225%
10"	250%
12"	300%

4" Coffee Cup 1

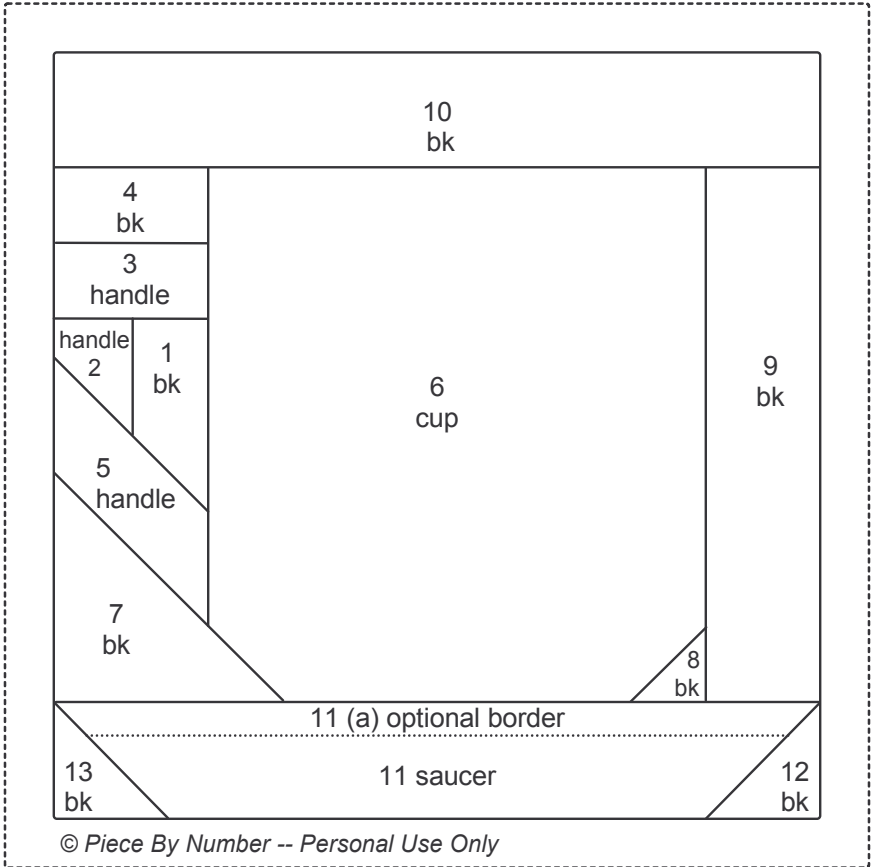
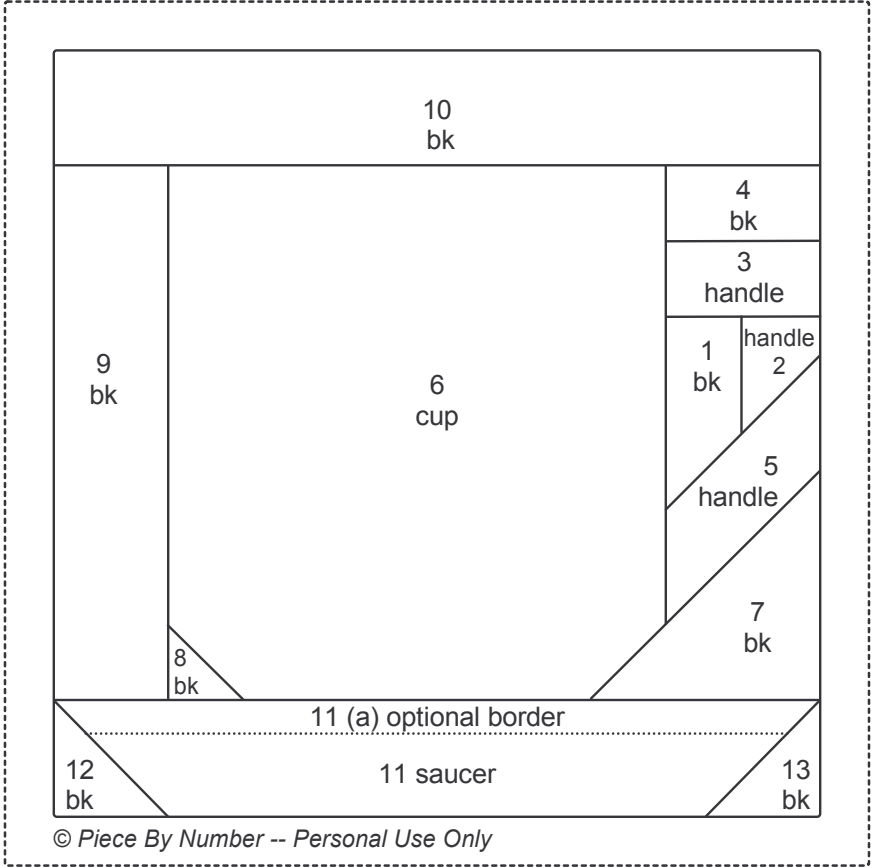

1" (2.54 cm)

print size check

4" Teacup 1

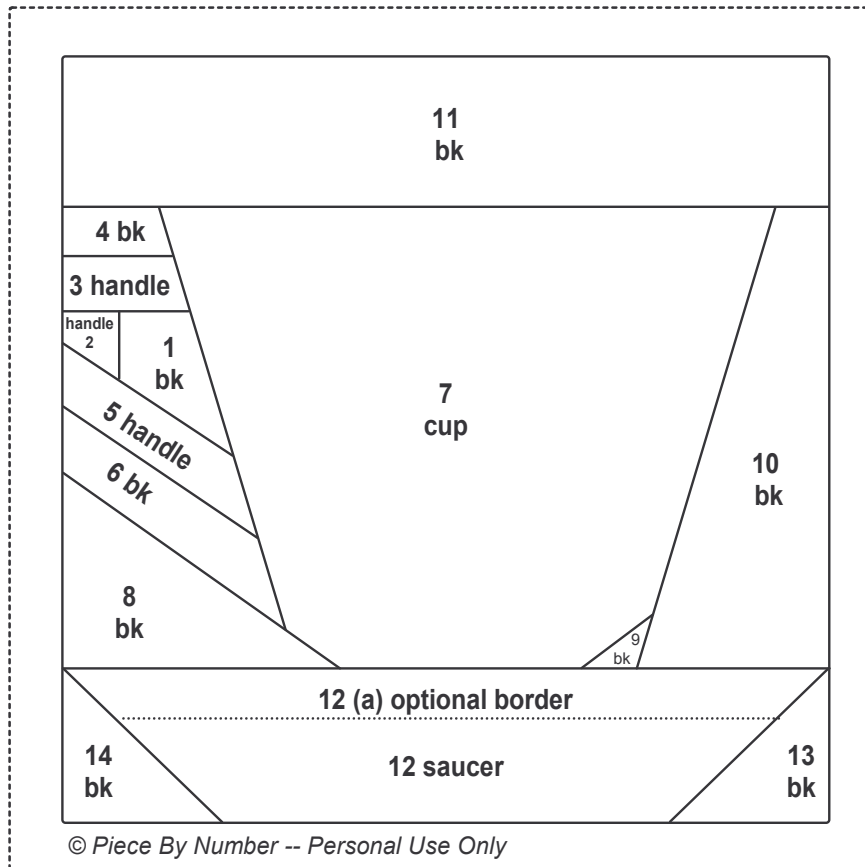
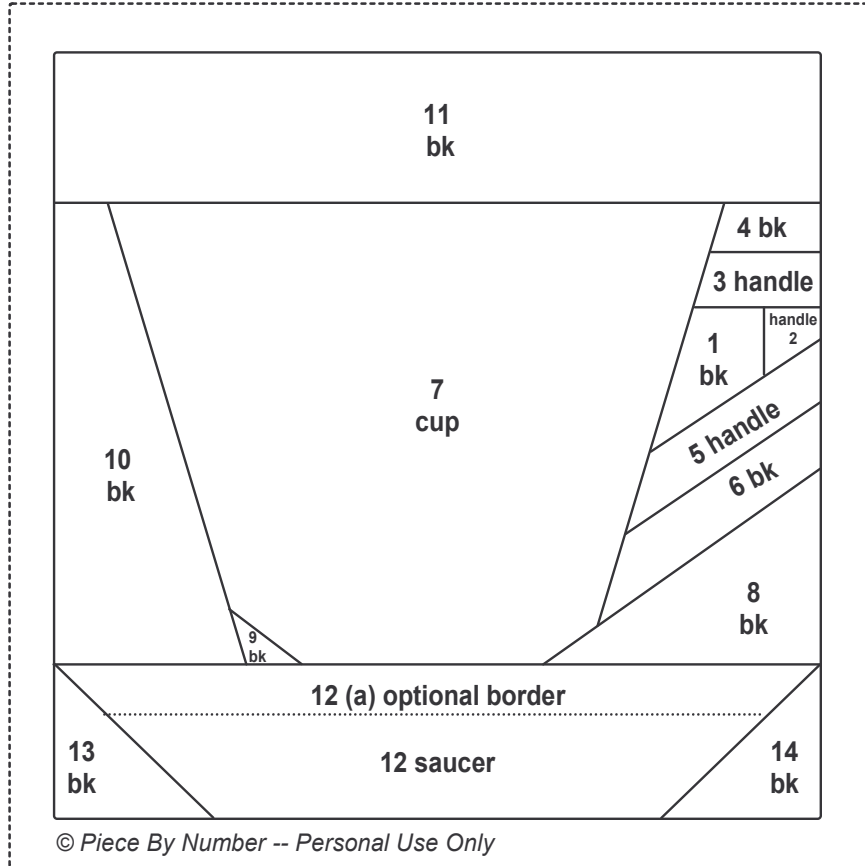

1" (2.54 cm)



print size check

4" Teacup 2

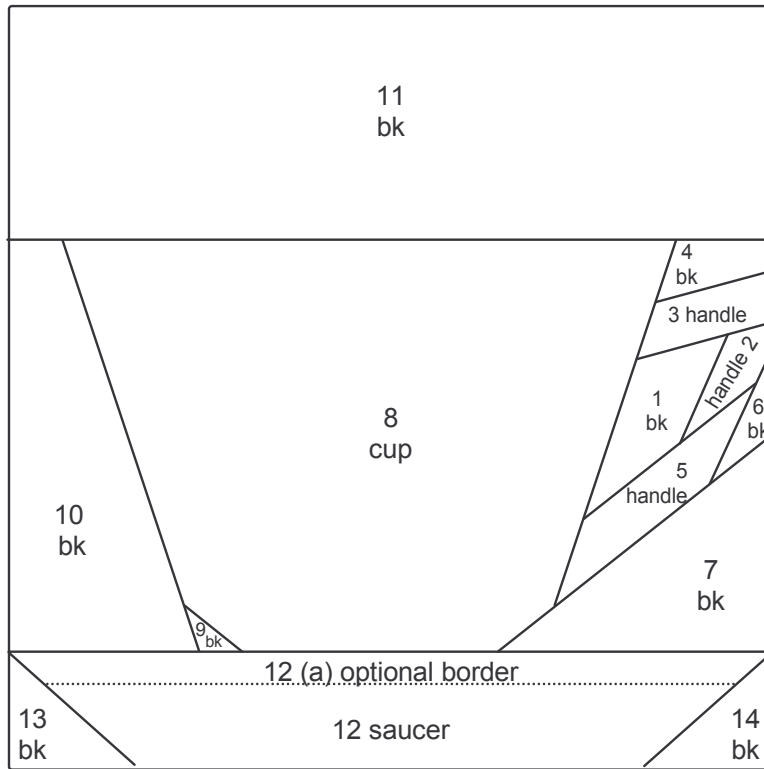

© Piece By Number -- Personal Use Only

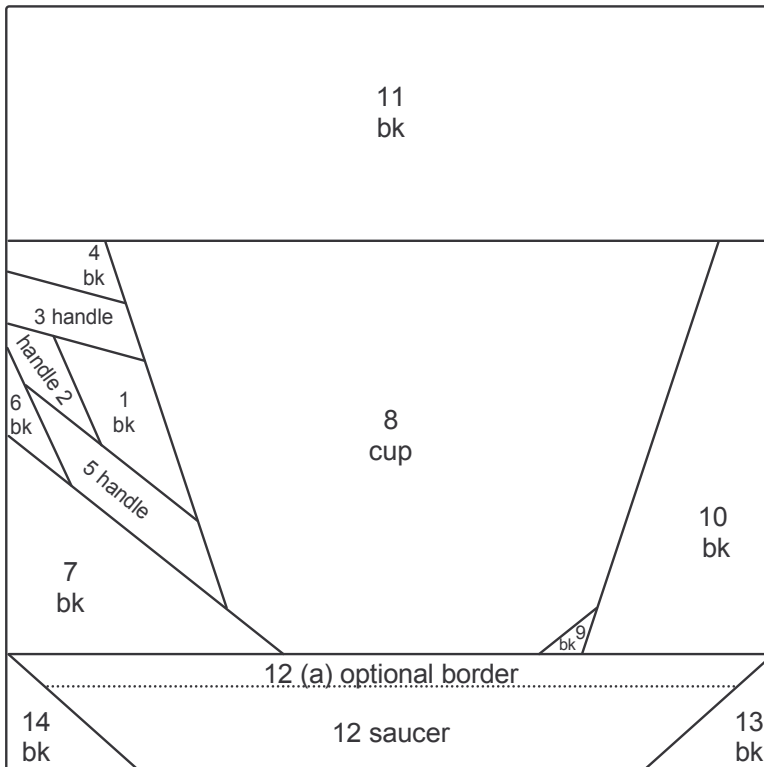

© Piece By Number -- Personal Use Only

1" (2.54 cm)



print size check

4" Coffee Cup 2

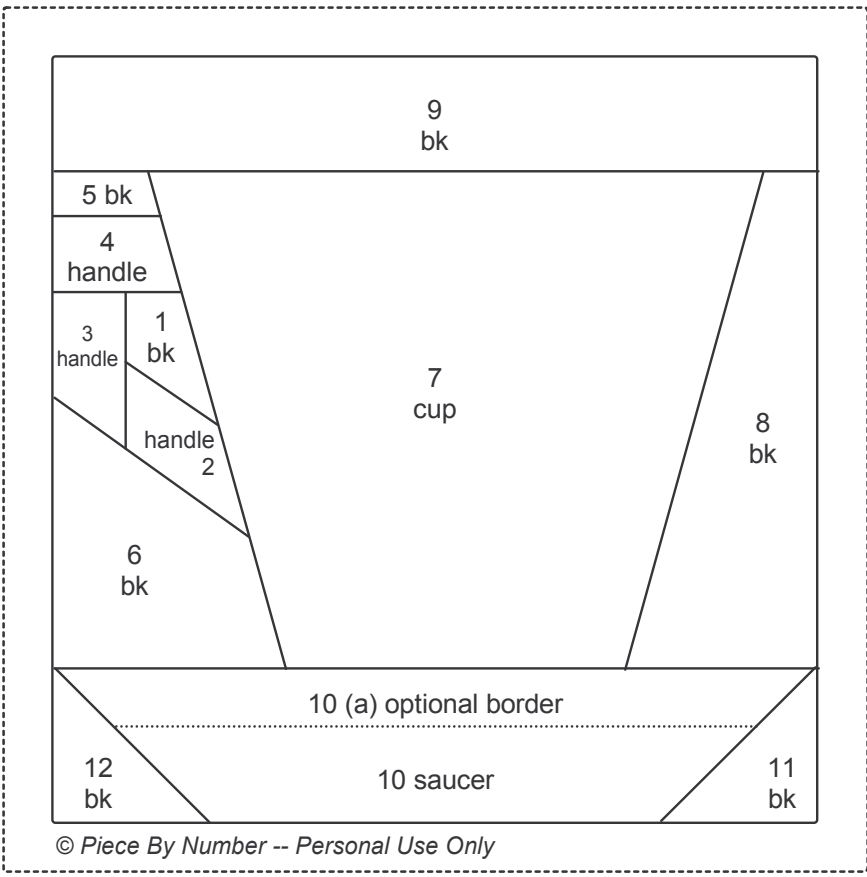
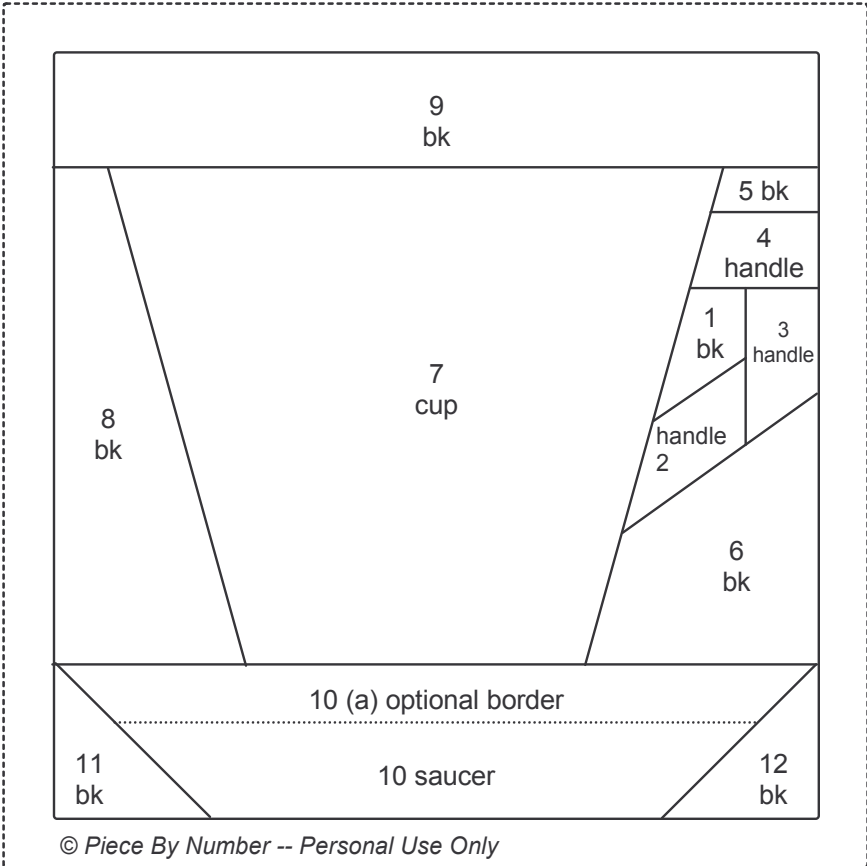

1" (2.54 cm)

 print size check

Teacup and Coffee Cup Blocks

